

产品. 规格书

PRODUCT SPECIFICATION

产品名称

Product Name

450激光器

产品编号

Product Number

K66B200W-T

规格型号

Specification Model

66*63*109mm

东莞市蓝宇激光有限公司

Dongguan Blueuniverse Laser Co, Ltd

DESCRIPTION. :

(规格书)

SPECIFICATION

THESE SPECIFICATIONS ARE THE PROPERTY OF DONGGUAN BLUEUNIVERSE LASER CO., LTD. AND SHALL NOT BE REPRODUCED OR USED AS THE BASIS FOR THE MANUFACTURE OR SELL OF APPARATUSES OR DEVICES WITHOUT PERMISSION.

Model No. :

K66B200W-T

日期

制定

品管

审核

核准

Document No. :

LY-WI-RD-F2102

REV

A0

产品参数

PRODUCT PARAMETERS

| 项目 Items | 参数 Parameter | 项目 Items | 参数 Parameter |
|------------------------------|-------------------------|-----------------------------|-----------------|
| 结构尺寸: Housing size | 66*63*109mm | 透镜: Optical Lens | Φ10/玻璃 |
| 电路板尺寸: Circuit Board Size | 45*81mm | 风扇: Fan | 24V/双滚珠7500转 |
| 电路板: Circuit Board | 24V/PWM调制板 | 产品材质: Product Material | 铝6061 |
| 线材: Wire Rod | 22# 2P2.54端子反线 120mm | 产品净重: Product Net Weight | / |

光电参数

OPTICAL PARAMETERS

TC=25℃

| 项目 Items | 符号 Symbol | 最小 Min | 标准 Typ | 最大 Max | 单位 Unit | 条件 Condition |
|----------------------------|-----------------|-----------|-----------|-----------|------------|-----------------|
| 光输出功率: Optical Output | P _o | 17 | / | / | W | |
| 工作电流: Working current | I _{op} | / | 2.9 | 3.2 | A | |
| 工作电压: Operating Voltage | V _{op} | / | 24 | / | V | |
| 激光波长: Laser Wavelength | λ _p | 450 | 455 | 460 | nm | |
| 电功率: Electric Power | W _l | / | 69.2 | 76.8 | W | |

| | | | |
|--------------------------|--------|-------------------------------|------------|
| 光斑模式: Laser Beam Mode | 点状 | 工作模式: Working Mode | Pulse work |
| 焦距: The focal length | 40±1mm | 工作温度: Working Temperature | 0℃至70℃ |
| 焦点大小: The focus size | <0.5mm | 储存温度: Storage Temperature | -40℃至85℃ |
| 工作时间: Working Time | 10000H | 外壳带电极性: Enclosure Polarity | 空 |

外形尺寸

DIMENSIONS

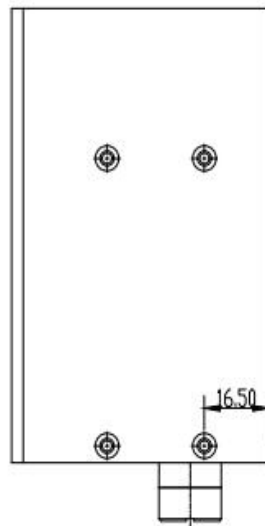
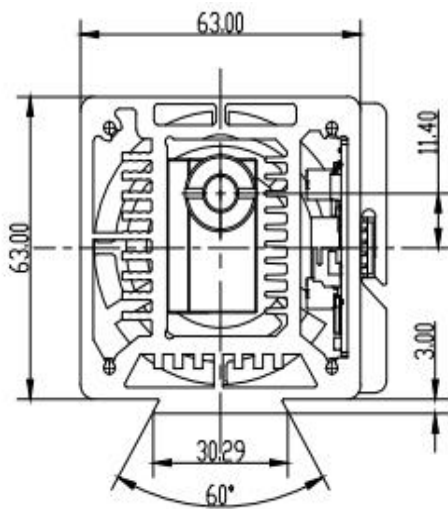
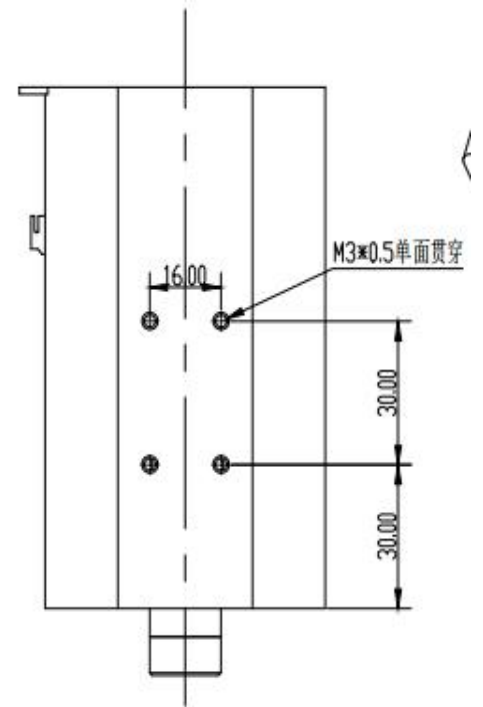
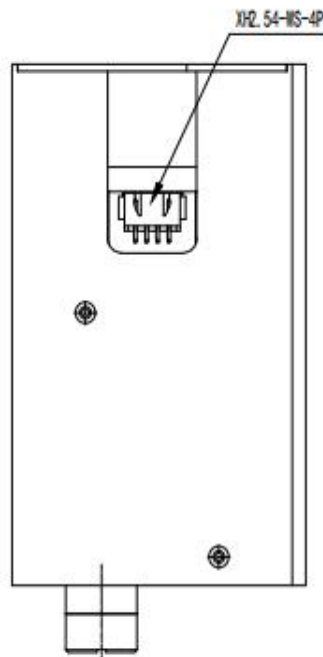
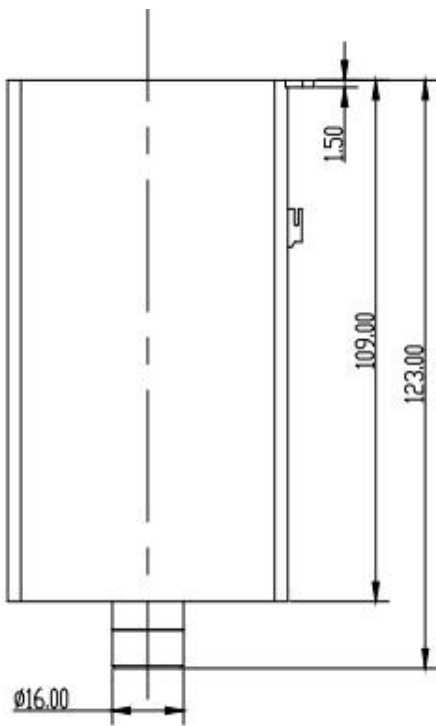
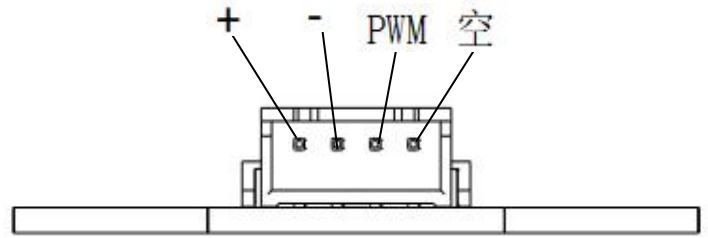
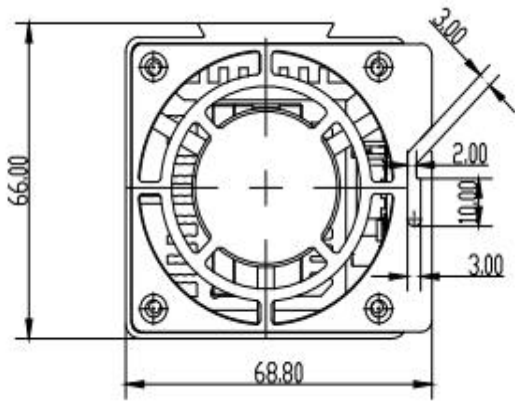

| UNSPECIFIED DIMENSINO TOL (GB/T1804-92) | | | VERSION |
|---|-----------|-----------|-----------|
| | COARSENES | COARSENES | |
| 0.5~3 | ±0.02 | ±0.03 | |
| 3~6 | ±0.03 | ±0.04 | |
| 6~30 | ±0.05 | ±0.1 | SCALE: 1: |
| 30~120 | ±0.2 | ±0.8 | 1 |
| 120~400 | ±0.5 | ±1.2 | UNITS: MM |
| UNSPECIFIED ANGLE OL (GB11359-89-M) ±1° | | | |
| FROM NO:FR-04-0013 REVISION:REVO | | | |
| DATE 2016-4-11 | | | |

注 意 事 项

CAUTIONS

1. 激光模组发射的激光有可能对眼睛造成伤害。激光模组工作时，严禁直接注视其端面，并佩戴防护眼镜。

The laser light emitted by the laser module is likely to injure persons' eye, so do not directly gaze its end surface and wear appropriate safety glasses to prevent laser light when it is working.

2. 器件需要合适的驱动电源，激光模组和电源连接时，电源输出电压应为零；电流调节时应缓慢增加或减少，以免冲击电流损坏器件。

Laser module needs an appropriate laser driver(PCB). When the laser module connects with power supply, please set the output voltage to zero. The adjustment of the current should be slowly increased or decrease to avoid damaging the device.

3. 器件应当存放或工作于干燥环境，防尘等级达到百万级，已免镜片落入灰尘影响光斑。

Keep the device working or storing in a dry environment. The anti-dust grade is over one million, in order to prevent dust inside the lens to affect the laser dot shape.

4. 在较高温度下工作，会增大阈值电流，降低转换效率，加速器件的老化。

Working at high temperatures will increase the threshold current, reduce conversion efficiency and speed up the aging of the device.

5. 输出功率高于指定参数工作，会加速器件老化。

When output power is higher than it's specific parameter of operation, it will accelerate the aging of the device.

6. 连续工作中激光管温度达到70℃要做好散热。

When the operation temperature of the laser diode is over 70degree, please do well heat dissipation of it.

7. 本产品属于静电敏感器件，在人体有良好接地的情况下才可拿取，防静电可采用防静电手镯的方法。

This laser module is an electrostatic sensitive device. Please make sure ground yourself or wear an antistatic wrist strap before you take it.



Dongguan Blueuniverse Laser
Co.,Ltd
400-7777-956
<http://www.bu-laser.Com>

东莞市蓝宇激光有限公司

Dongguan Blueuniverse Laser Co.,Ltd

DESCRIPTION.:

(规格书)

SPECIFICATION

THESE SPECIFICATIONS ARE THE PROPERTY OF DONGGUAN BLUEUNIVERSE LASER CO.,LTD. AND SHALL NOT BE REPRODUCED OR USED AS THE BASIS FOR THE MANUFACTURE OR SELL OF APPARATUSES OR DEVICES WITHOUT PERMISSION.

Model No.:

K69B200W-CK-C

Document No.:

LY-WI-RD-F2099

REV

A0